



Tank heaters

type
EHP
EH
TEHM



Type EHP



Type EH



Type TEHM



Tank heaters suit for preheating hydraulic, lubricating and temperature control units and are to prevent breakdowns generated by an insufficiently tempered medium.

If the starting temperature of the medium is too low, the viscosity is higher than with operating temperature. This results in higher friction and cavitation on pumps and motors so that the components wear off earlier and the service life of the overall system is affected.

Table of contents

1	Technische Daten	3
1.1	Type EHP	3
1.2	Type EH	4
1.3	Type TEHM	5
2	Hinweise	6
2.1	Allgemeine Hinweise	6
2.2	Sicherheits- und Hinweiszeichen	6
2.3	Allgemeiner Gefahrenhinweis	6
2.4	Bestimmungsgemäße Verwendung	6
3	Lagerung, Transport und Verpackung	7
3.1	Lagerung	7
3.2	Transport und Verpackung	7
4	Montage der Tankheizungen	7
4.1	Einschraubheizpatrone - Type EHP	7
4.2	Einschraubrohrheizkörper - Type EH	8
4.3	Tankeinbauheizung - Type TEHM	8
5	Elektrische Anschlüsse	9
6	Inbetriebnahme	10
7	Entsorgung	10
8	Wartung und Instandhaltung	10
9	Ersatzteilkhaltung, Kundendienstadressen	11
10	EU-Konformitätserklärung	12



1 Technical data

1.1 Type EHP

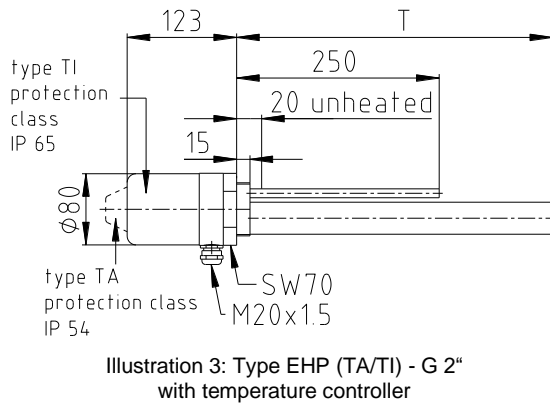
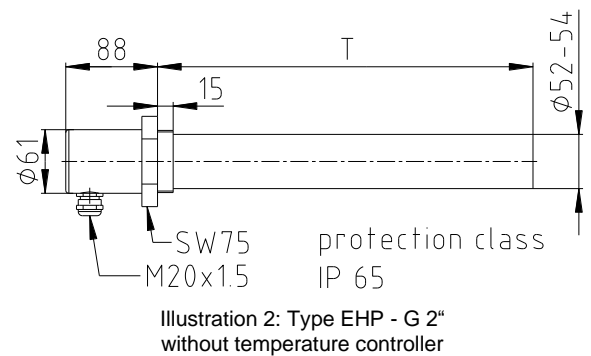
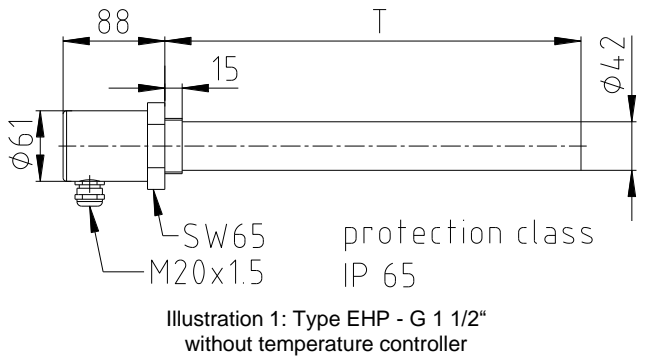

Table 1: Dimensions and technical data - type EHP

G 1 1/2" without temperature controller			G 2" without temperature controller			G 2" with temperature controller		
Heating capacity in watts	Immersion depth T in mm	Voltage in V	Heating capacity in watts	Immersion depth T in mm	Voltage in V	Heating capacity in watts	Immersion depth T in mm	Voltage in V
400	200	230	500	200	230	450	300	230
600	300	230	750	300	230	600	400	230
800	400	230	1000	400	230	750	500	230
1000	500	230	1250	500	230	900	600	230
1200	600	230	1450	600	230	1050	700	230
1400	700	230	1700	700	230	1200	800	230
1600	800	230	1950	800	230	1350	900	230
1800	900	230	2200	900	230	1500	1000	230
2000	1000	230	2450	1000	230	1650	1100	230
2200	1100	230	2700	1100	230	1800	1200	230
2400	1200	230	2950	1200	230	1950	1300	230
2800	1400	230	3450	1400	3x400	2100	1400	230
3200	1600	230	3900	1600	3x400	2250	1500	230
3600	1800	3x400	4400	1800	3x400	2400	1600	230
4000	2000	3x400	4900	2000	3x400			



The standard devices listed in table 1 are selected for hydraulic oils with a permissible surface load of 1.5 W/cm².

Please observe protection note ISO 16016.	Drawn:	2023-03-09 Pz/Ha	Replacing:	KTR-N dated 2013-04-12
	Verified:	2023-03-10 Pz	Replaced by:	



1 Technical data

1.2 Type EH

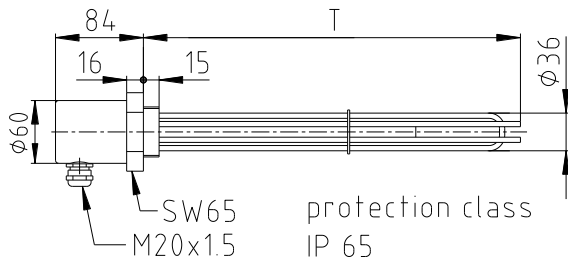

Illustration 4: Type EH - G 1 1/2" without temperature controller

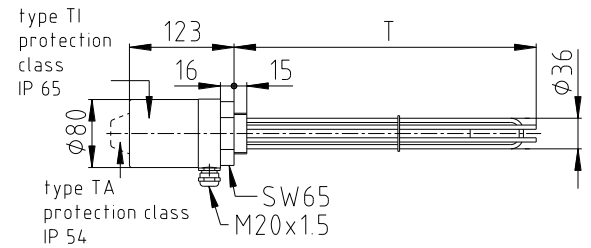

Illustration 5: Type EH (TA/TI) - G 1 1/2" with temperature controller for external resp. internal adjustment

Table 2: Dimensions and technical data - type EH

G 1 1/2" without resp. with temperature controller		
Heating capacity in watts	Immersion depth T in mm	Voltage in V
380	200	230
500	250	230
750	350	230
990	450	230
1460	650	230
1825	800	230
2300	1000	230



The standard devices listed in table 2 are selected for hydraulic oils with a permissible surface load of 1.5 W/cm².

1 Technical data

1.3 Type TEHM

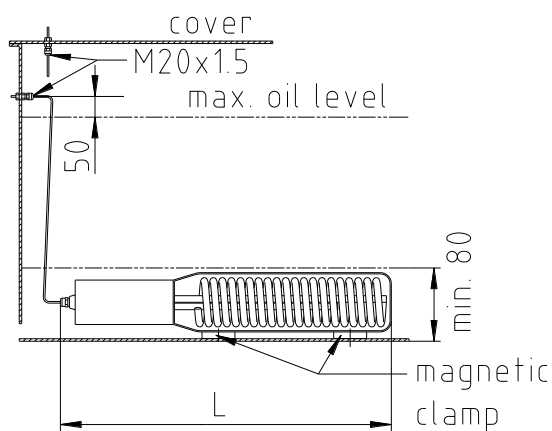

Illustration 6: Type TEHM

Table 3: Dimensions and technical data - type TEHM

Heating capacity in watts	Total length L in mm	Voltage in V
250	265	230
500	290	230
1000	400	230



The permissible surface load of the medium has to be reviewed and assured by the user.

**2 Advice****2.1 General advice**

Read carefully through these operating/assembly instructions before you start up the tank heater.

Pay special attention to the safety instructions!

The operating/assembly instructions are part of your product. Please store them carefully and close to the tank heater. The copyright for these operating/assembly instructions remains with KTR.

2.2 Safety and advice symbols**Warning of personal injury**

This symbol indicates notes which may contribute to preventing bodily injuries or serious bodily injuries that may result in death.

**Warning of product damages**

This symbol indicates notes which may contribute to preventing material or machine damage.

**General advice**

This symbol indicates notes which may contribute to preventing adverse results or conditions.

**Warning of hot surfaces**

This symbol indicates notes which may contribute to preventing burns with hot surfaces resulting in light to serious bodily injuries.

2.3 General hazard warnings

With assembly, operation and maintenance of the tank heater it has to be made sure that the entire drive train is secured against accidental switch-on and the plant is unpressurized. You may be seriously hurt by hot or pressurized hydraulic oil and the heated tank heater. Make absolutely sure to read through and observe the following safety indications.

- **All operations on and with the tank heater have to be performed taking into account "safety first".**
- Make sure to switch off the power packs before you perform your work on the tank heater.
- Secure the power pack against accidental switch-on, e. g. by providing warning signs at the place of switch-on or removing the fuse for current supply.

2.4 Intended use

You may only assemble, operate and maintain the tank heater if you

- have carefully read through the operating/assembly instructions and understood them
- are technically qualified and specifically trained (e. g. safety, environment, logistics)
- are authorized by your company

The tank heater may only be used in accordance with the technical data. Unauthorized modifications on the tank heater design are not admissible. We will not assume liability for any damage that may arise. In the interest of further development we reserve the right for technical modifications.

The **tank heater** described in here corresponds to the state of the art at the time of printing of these operating/assembly instructions.

**3 Storage, transport and packaging****3.1 Storage**

The tank heaters must be stored with a temperature of approx. 20 °C and can be stored in a dry place for 5 - 6 months.



**Humid storage rooms are not suitable.
Make sure that condensation is not generated. The best relative air humidity is less than 65 %.**

3.2 Transport and packaging

In order to avoid any injuries and any kind of damage always make use of proper transport and lifting equipment.

The tank heaters are packed differently each depending on size, number and kind of transport, only dry packaging material should be used. Unless otherwise contractually agreed, packaging will follow the in-house packaging specifications of KTR.



In case of subsequent drying because of bad insulating parameters, the tank heaters should be placed in a kiln with approx. 100 - 120 °C overnight. Usually the tank heaters can easily be used after cooling.

4 Assembly of tank heaters**4.1 Inserted heating cartridge - type EHP**

- Mount the heating cartridge with a gasket suitable for the liquid on the counter flange. Here the cable glands should face down, if possible.
- Screw the heating cartridges horizontally under the oil level in the sleeve provided in the tank. The minimum oil level of 50 mm above the heating cartridge must not be fallen below.
- For devices with a temperature controller the user is responsible for setting the switch-off temperature (switching accuracy ± 3 °C).
- The ceramic heating inserts are replaceable and must be mounted without draining the oil.
- The permissible surface load of the medium has to be reviewed and assured by the user.



With devices without an integrated temperature controller a separate (external) control of the temperature is required (see KTR industrial controllers).

**4 Assembly of tank heaters****4.2 Inserted tubular heaters - type EH**

- Mount the inserted tubular heaters with a gasket suitable for the liquid on the counter flange. Here the cable glands should face down, if possible.
- Screw the inserted tubular heaters horizontally under the oil level in the sleeve provided in the tank. The minimum oil level of 50 mm above the inserted tubular heaters must not be fallen below.
- For devices with a temperature controller the user is responsible for setting the switch-off temperature (switching accuracy ± 3 °C).
- The permissible surface load of the medium has to be reviewed and assured by the user.



With devices without an integrated temperature controller a separate (external) control of the temperature is required (see KTR industrial controllers).



Usually faulty devices can only be replaced after full draining of the tank.

4.3 Inserted tank heater - type TEHM

- The permissible surface load for hydraulic oil on a mineral oil basis with standard devices is 1.2 W/cm².
Devices with 0.6 W/cm² are available on request.
- The temperature control of the standard devices is made by an integrated controller with a preset switch-off temperature of 20 °C. With a switching accuracy of ± 3 °C the device switches on again with approx. 17 °C.
- The tank heater is mounted horizontally on the tank ground or vertically on the tank wall Fastening via magnetic clamps. It must be ensured that the tank heater is always positioned below oil level. Dry running of the tank heater must be excluded.
The connection cable is fed outwards through the wall or the cover and fastened with cable gland supplied.
- Electrical connection acc. to the attached wiring diagram (see illustrations 8 to 11) to be connected by specialists only.

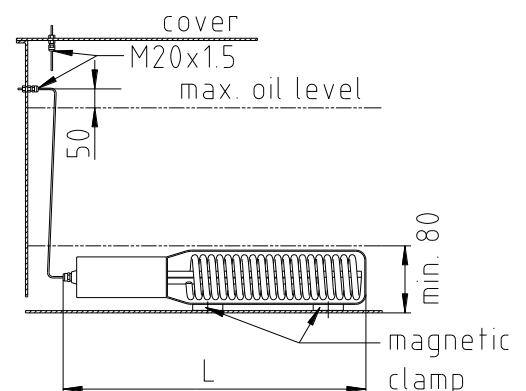

Illustration 7: Installation scheme - TEHM



The permissible surface load of the medium has to be reviewed and assured by the user.



5 Electrical connections

A supply line based on the ambient temperatures arising must be used. The cross section must be dimensioned acc. to VDE 0100. A wiring diagram of the inserted heating cartridge is attached in the connection housing. The temperature controllers must be set to the requested operating temperature by the customer.

If a safety temperature limit (STB) exists:

The safety temperature limit fully switches off the plant if the thermostat fails and may only be switched on again by a specialist once the failure has been sorted out.

The devices can be connected to the following operating voltages:

Connection to 220 V/230 V (1 phase A. C. and 2x380 V/2x400 V (2 phase A. C.))

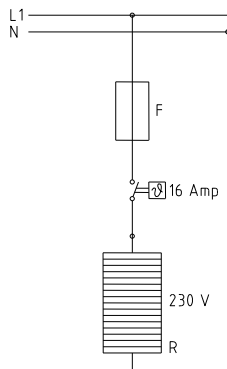

Illustration 8: Wiring diagram with thermostat - 230 V

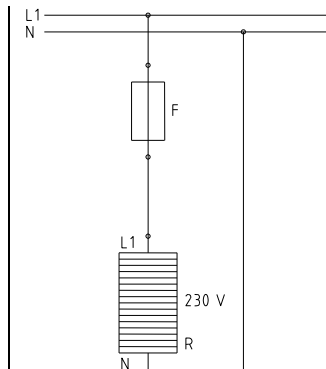

Illustration 9: Wiring diagram without thermostat - 230 V

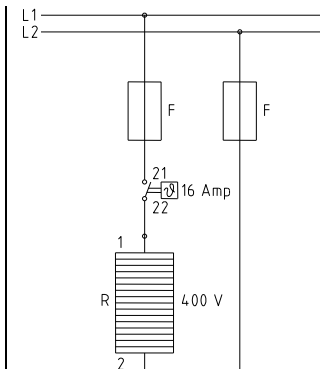

Illustration 10: Wiring diagram with thermostat - 400 V

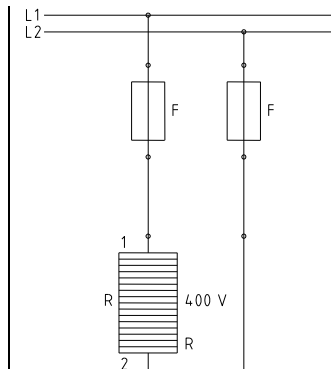

Illustration 11: Wiring diagram without thermostat - 400 V

Connection to A. C. current

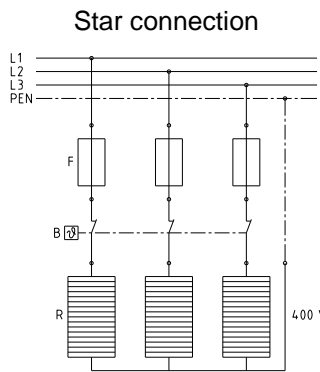

Illustration 12: Wiring diagram with thermostat - 400 V ⋄

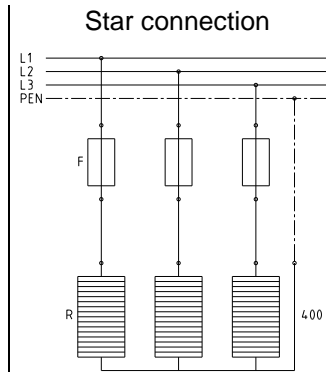

Illustration 13: Wiring diagram with thermostat - 400 V ⋄

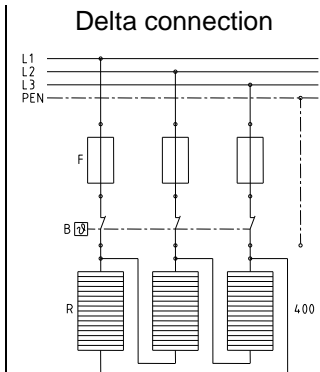

Illustration 14: Wiring diagram with thermostat - 400 V Δ

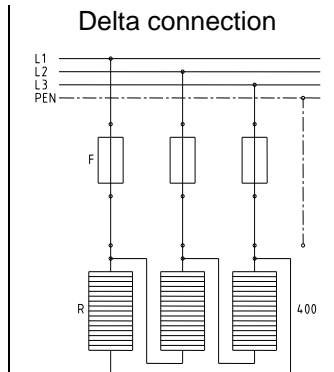

Illustration 15: Wiring diagram with thermostat - 400 V Δ

Circuit symbols:

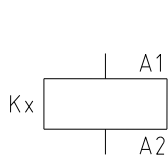

Illustration 16: Protection

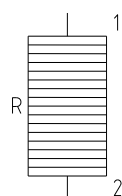

Illustration 17: Heating resistor

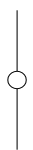

Illustration 18: Connection pin

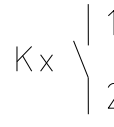

Illustration 19: Contactor contact

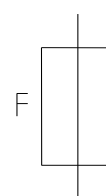

Illustration 20: Fuse

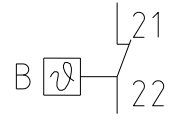

Illustration 21: Thermostat

 KTR-Group	Tank heater Operating/Assembly instructions	KTR-N 41810 EN Sheet: 10 of 12 Edition: 3
---	--	---

5 Electrical connections



Install the electrical connection according to the attached wiring diagram (see chapter 5).



The electrical connection may only be carried out by qualified staff. The relevant regulations must be observed.

6 Start-up



All necessary settings and potential operations are described in the present operating instructions. If there are difficulties with the start-up anyway, we would ask you not to carry out any impermissible operations on the device. You might endanger your warranty claim. Please contact KTR.

7 Disposal

In respect of environmental protection we would ask you to dispose of the packaging resp. products on termination of their service life in accordance with the legal regulations resp. standards that apply.

8 Maintenance and service

We would recommend inspection of the covering in suitable intervals. The covering must be removed, if necessary.



With damages by covering and corrosion the warranty commitment shall not apply.

After an operating period of 1 month all supply terminals shall be retightened. Here the terminals for supply lines of heating elements are to be retightened, too. Another maintenance is not necessary.

Please observe protection note ISO 16016.	Drawn: 2023-03-09 Pz/Ha	Replacing: KTR-N dated 2013-04-12
	Verified: 2023-03-10 Pz	Replaced by:

	Tank heater Operating/Assembly instructions	KTR-N 41810 EN Sheet: 11 of 12 Edition: 3
--	--	---

9 Spares inventory, customer service addresses

We recommend to store major spare parts on site to ensure the readiness for use of the machine in case if a tank heater fails.

Contact addresses of the KTR partners for spare parts and orders can be obtained from the KTR homepage at www.ktr.com.



KTR does not assume any liability or warranty for the use of spare parts and accessories which are not provided by KTR and for the damages which may incur as a result.

KTR Systems GmbH
Carl-Zeiss-Str. 25
D-48432 Rheine
Phone: +49 5971 798-0
E-mail: mail@ktr.com

Please observe protection note ISO 16016.	Drawn: 2023-03-09 Pz/Ha	Replacing: KTR-N dated 2013-04-12
	Verified: 2023-03-10 Pz	Replaced by:



10 EU Declaration of conformity

EU Declaration of conformity

The manufacturer - KTR Systems GmbH, Carl-Zeiss-Str. 25, D-48432 Rheine - states that the

**Inserted heating cartridge - type EHP
Inserted tubular heaters - type EH
Inserted tank heater - type TEHM**

described in the present operating instructions are in accordance with the following standards:

- | | |
|------------|---|
| 2014/35/EU | Low-voltage directive (LVD) |
| 2011/65/EU | RoHS-Richtlinie |
| | Restriction of the use of certain hazardous substances in electrical and electronic equipment |

The tank heaters described in here comply with the specifications of the following standards/rules:

- DIN EN 60204-1:2019-06; VDE 0113-1:2019-06
- DIN EN 60335-1:2020-08; VDE 0700-1:2020-08
- DIN EN 60730 / VDE 0631
- VDE 0100
- VDE 0298

Restrictions:

The products designated are merely intended for installation in a plant. Start-up is not allowed before the plant complies with the regulations of the EU standards.
This EU declaration of conformity is no assurance of characteristics in the sense of the product liability law.

Rheine,
Place

2023-03-09
Date

i. V. 

Christoph Bettmer
Product Manager