

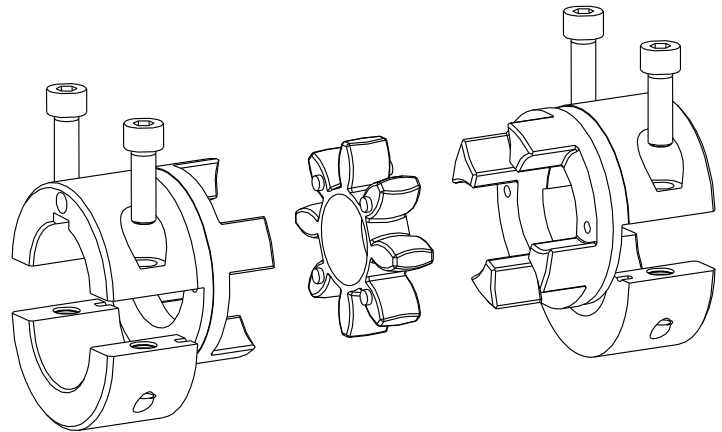

# ROTEX®

Torsionally flexible jaw-type couplings  
type A-H  
and their combinations

according to directive 2014/34/EU  
for finish bored, pilot bored and  
unbored couplings



**Type A-H,  
Size 19 - 90**

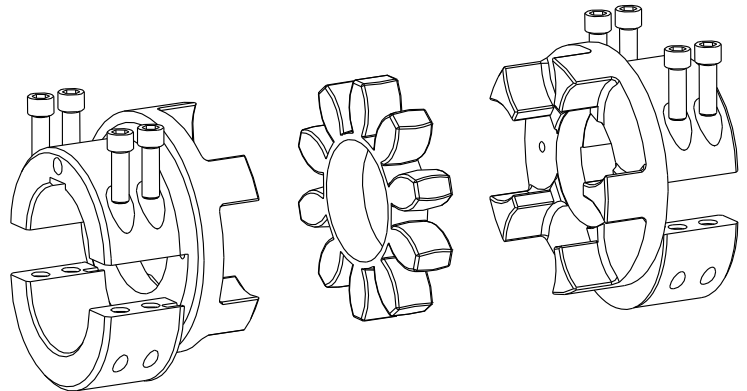





**Type A-H,  
Size 100 - 125**

|  |  |  |
|--|--|--|
|  | <b>ROTEX®</b><br><b>Operating/Assembly instructions</b><br><b>Type A-H</b> | KTR-N 40226 EN<br>Sheet: 2 of 19<br>Edition: 4 |
|--|--|--|

ROTEX® is a torsionally flexible jaw coupling. It is able to compensate for shaft misalignment, for example caused by manufacturing inaccuracies, thermal expansion, etc.  
 Type A-H allows to replace a spider/coupling without having to disassemble the driving or driven machine, respectively.

## Table of contents

|           |   |           |
|-----------|---|-----------|
| <b>1</b>  | <b>Technical data</b>   | <b>3</b>  |
| <b>2</b>  | <b>Advice</b>   | <b>4</b>  |
| 2.1       | General advice  | 4         |
| 2.2       | Safety and advice symbols   | 5         |
| 2.3       | General hazard warnings   | 5         |
| 2.4       | Intended use  | 5         |
| 2.5       | Coupling selection  | 6         |
| 2.6       | Reference to EC Machinery Directive 2006/42/EC  | 6         |
| <b>3</b>  | <b>Storage, transport and packaging</b>   | <b>6</b>  |
| 3.1       | Storage   | 6         |
| 3.2       | Transport and packaging   | 6         |
| <b>4</b>  | <b>Assembly</b>   | <b>7</b>  |
| 4.1       | Components of the coupling  | 7         |
| 4.2       | Advice for finish bore  | 8         |
| 4.3       | Assembly of the hubs  | 9         |
| 4.4       | Displacements - alignment of the couplings  | 9         |
| <b>5</b>  | <b>Start-up</b>   | <b>11</b> |
| <b>6</b>  | <b>Breakdowns, causes and elimination</b>   | <b>12</b> |
| <b>7</b>  | <b>Disposal</b>   | <b>14</b> |
| <b>8</b>  | <b>Maintenance and service</b>  | <b>14</b> |
| <b>9</b>  | <b>Spares inventory, customer service addresses</b>   | <b>14</b> |
| <b>10</b> | <b>Enclosure A</b>  |           |
|           | <b>Advice and instructions regarding the use in  hazardous locations</b> | <b>15</b> |
| 10.1      | Intended use in  potentially explosive atmospheres                       | 15        |
| 10.2      | Inspection intervals for couplings in  potentially explosive atmospheres | 16        |
| 10.3      | Standard values of wear   | 17        |
| 10.4      | Permissible coupling materials in  potentially explosive atmospheres     | 17        |
| 10.5      |  marking of coupling for potentially explosive atmospheres               | 18        |
| 10.6      | EU Certificate of conformity  | 19        |

|   |                         |                                   |
|---|-------------------------|-----------------------------------|
| Please observe protection note ISO 16016. | Drawn: 2017-05-24 Pz/At | Replacing: KTR-N dated 2017-05-16 |
|   | Verified: 2017-05-30 Pz | Replaced by:                      |

**1 Technical data**

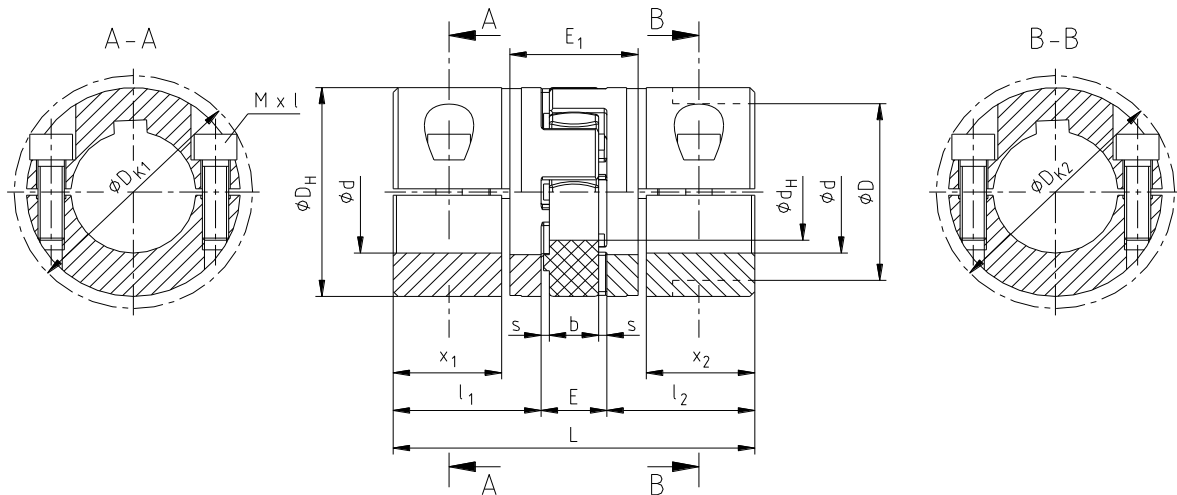

Illustration 1: ROTEX®, type A-H (material: steel)

**Table 1: Material steel**

| Size | Spider <sup>1)</sup> (component 2)<br>Rated torque [Nm] |        |        | Dimensions [mm] |            |    |    |     |       |       |
|------|---|--------|--------|-----------------|------------|----|----|-----|-------|-------|
|      | 92 ShA  | 98 ShA | 64 ShD | General         |            |    |    |     |       |       |
| 19   | 10  | 17     | 21     | L               | $l_1; l_2$ | E  | b  | s   | $D_H$ | $d_H$ |
| 24   | 35  | 60     | 75     | 66              | 25         | 16 | 12 | 2.0 | 40    | 18    |
| 28   | 95  | 160    | 200    | 78              | 30         | 18 | 14 | 2.0 | 55    | 27    |
| 38   | 190   | 325    | 405    | 90              | 35         | 20 | 15 | 2.5 | 65    | 30    |
| 42   | 265   | 450    | 560    | 114             | 45         | 24 | 18 | 3.0 | 80    | 38    |
| 48   | 310   | 525    | 655    | 126             | 50         | 26 | 20 | 3.0 | 95    | 46    |
| 55   | 410   | 685    | 825    | 140             | 56         | 28 | 21 | 3.5 | 105   | 51    |
| 65   | 625   | 940    | 1175   | 160             | 65         | 30 | 22 | 4.0 | 120   | 60    |
| 75   | 1280  | 1920   | 2400   | 185             | 75         | 35 | 26 | 4.5 | 135   | 68    |
| 90   | 2400  | 3600   | 4500   | 210             | 85         | 40 | 30 | 5.0 | 160   | 80    |
|      |   |        |        | 245             | 100        | 45 | 34 | 5.5 | 200   | 100   |

| Size | Max. finish bore <sup>2)</sup><br>d (min-max) | Dimensions [mm] |          |          |           |       |          |     | Cap screws<br>DIN EN ISO 4762 |            |
|------|---|-----------------|----------|----------|-----------|-------|----------|-----|-------------------------------|------------|
|      |   | General         |          |          |           |       |          |     | M x l                         | $T_A$ [Nm] |
| 19   | 20  | -               | $D_{K1}$ | $D_{K2}$ | $x_1/x_2$ | $E_1$ |          |     |                               |            |
| 24   | 28  | -               | 46.0     | -        | 17.5      | 31    | M6 x 16  | 14  |                               |            |
| 28   | 38  | -               | 57.5     | -        | 22.5      | 33    | M6 x 20  | 14  |                               |            |
| 38   | 45  | -               | 73.0     | -        | 25.5      | 39    | M8 x 25  | 35  |                               |            |
| 38   | 45  | -               | 83.5     | -        | 35.5      | 43    | M8 x 30  | 35  |                               |            |
| 42   | 50  | 85              | -        | 93.5     | 39.0      | 48    | M10 x 30 | 69  |                               |            |
|      | 55  | -               | 97.0     | -        |           |       |          |     |                               |            |
| 48   | 55  | 95              | -        | 105.0    | 45.0      | 50    | M12 x 35 | 120 |                               |            |
|      | 60  | -               | 108.5    | -        |           |       |          |     |                               |            |
| 55   | 65  | 110             | -        | 119.5    | 50.0      | 60    | M12 x 40 | 120 |                               |            |
|      | 70  | -               | 122.0    | -        |           |       |          |     |                               |            |
| 65   | 70  | 115             | -        | 123.5    | 60.0      | 65    | M12 x 40 | 120 |                               |            |
|      | 80  | -               | 132.5    | -        |           |       |          |     |                               |            |
| 75   | 80  | 135             | -        | 147.5    | 67.5      | 75    | M16 x 50 | 295 |                               |            |
|      | 90  | -               | 158.0    | -        |           |       |          |     |                               |            |
| 90   | 90  | 160             | -        | 176.0    | 81.5      | 82    | M20 x 60 | 580 |                               |            |
|      | 110   | -               | 197.0    | -        |           |       |          |     |                               |            |

1) Maximum torque of the coupling  $T_{Kmax.}$  = rated torque of the coupling  $T_{Krated}$  x 2  
 2) Bores H7 with keyway to DIN 6885 sheet 1 [JS9]



## 1 Technical data

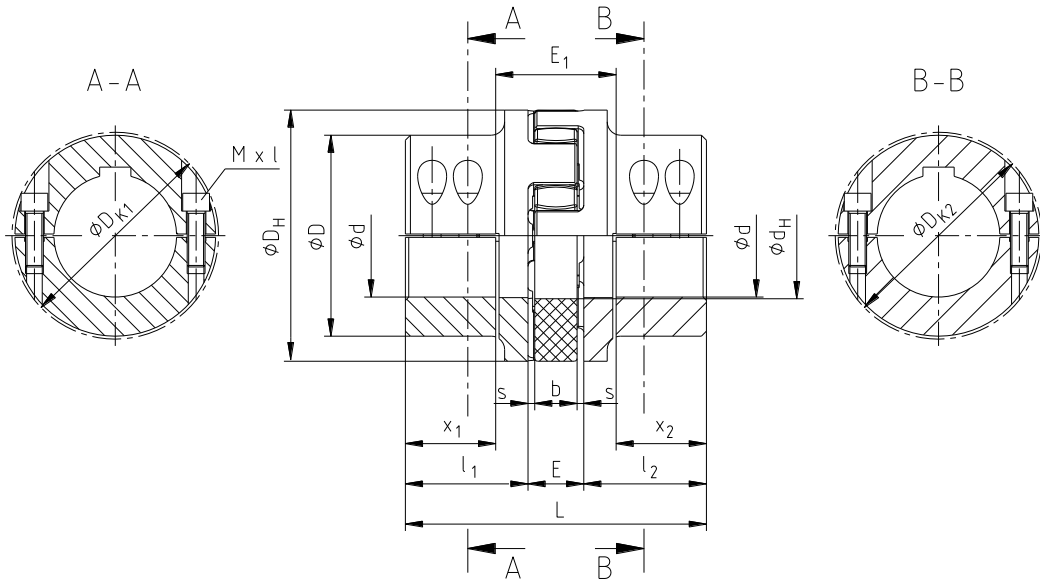

Illustration 2: ROTEX®, type A-H (material: EN-GJS-400-15)

**Table 2: Material EN-GJS-400-15**

| Size | Spider <sup>1)</sup> (component 2)<br>Rated torque [Nm] |        |        | Dimensions [mm] |            |    |    |     |       |       |
|------|---|--------|--------|-----------------|------------|----|----|-----|-------|-------|
|      | 92 ShA  | 98 ShA | 64 ShD | General         |            |    |    |     |       |       |
|      |   |        |        | L               | $l_1; l_2$ | E  | b  | s   | $D_H$ | $d_H$ |
| 100  | 3300  | 4950   | 6185   | 270             | 110        | 50 | 38 | 6.0 | 225   | 113   |
| 110  | 4800  | 7200   | 9000   | 295             | 120        | 55 | 42 | 6.5 | 255   | 127   |
| 125  | 6650  | 10000  | 12500  | 340             | 140        | 60 | 46 | 7.0 | 290   | 147   |

| Size | Max. finish bore <sup>2)</sup><br>d (min-max) | Dimensions [mm] |          |          |           |       | Cap screws<br>DIN EN ISO 4762 |            |
|------|---|-----------------|----------|----------|-----------|-------|-------------------------------|------------|
|      |   | D               | $D_{K1}$ | $D_{K2}$ | $x_1/x_2$ | $E_1$ | M x l                         | $T_A$ [Nm] |
| 100  | 110   | 180             | -        | 185.5    | 84        | 102   | M16 x 50                      | 295        |
| 110  | 120   | 200             | -        | 208.0    | 90        | 115   | M20 x 60                      | 580        |
| 125  | 140   | 230             | -        | 242.5    | 105       | 130   | M24 x 70                      | 1000       |

1) Maximum torque of the coupling  $T_{Kmax.}$  = rated torque of the coupling  $T_{K rated} \times 2$

2) Bores H7 with keyway to DIN 6885 sheet 1 [JS9]



**ROTEX® couplings with attachments that can generate heat, sparks and static charging (e. g. combinations with brake drums, brake disks, overload systems like torque limiters, fans etc.) are not permitted for the use in hazardous areas. A separate analysis must be performed.**

## 2 Advice

### 2.1 General advice

Please read through these operating/assembly instructions carefully before you start up the coupling. Please pay special attention to the safety instructions!



The **ROTEX®** coupling is suitable and approved for the use in hazardous locations. When using the coupling in potentially explosive atmospheres, please observe the special advice and instructions regarding safety in enclosure A.

The operating/assembly instructions are part of your product. Please store them carefully and close to the coupling. The copyright for these operating/assembly instructions remains with KTR.

Please observe protection note ISO 16016.

Drawn: 2017-05-24 Pz/At

Verified: 2017-05-30 Pz

Replacing: KTR-N dated 2017-05-16

Replaced by:

## 2 Advice

### 2.2 Safety and advice symbols



**Warning of potentially explosive atmospheres**

This symbol indicates notes which may contribute to preventing bodily injuries or serious bodily injuries that may result in death caused by explosion.



**Warning of personal injury**

This symbol indicates notes which may contribute to preventing bodily injuries or serious bodily injuries that may result in death.



**Warning of product damages**

This symbol indicates notes which may contribute to preventing material or machine damage.



**General advice**

This symbol indicates notes which may contribute to preventing adverse results or conditions.

### 2.3 General hazard warnings



**With assembly, operation and maintenance of the coupling it has to be made sure that the entire drive train is secured against accidental switch-on. You may be seriously hurt by rotating parts. Please make absolutely sure to read through and observe the following safety indications.**

- All operations on and with the coupling have to be performed taking into account "safety first".
- Please make sure to switch off the power pack before you perform your work on the coupling.
- Secure the power pack against accidental switch-on, e. g. by providing warning signs at the place of switch-on or removing the fuse for current supply.
- Do not reach into the operating area of the coupling as long as it is in operation.
- Please secure the coupling against accidental contact. Please provide for the necessary protection devices and covers.

### 2.4 Intended use

You may only assemble, operate and maintain the coupling if you

- have carefully read through the operating/assembly instructions and understood them
- had technical training
- are authorized by your company

The coupling may only be used in accordance with the technical data (see chapter 1). Unauthorized modifications on the coupling design are not admissible. We will not assume liability for any damage that may arise. In the interest of further development we reserve the right for technical modifications.

The **ROTEX®** described in here corresponds to the technical status at the time of printing of these operating/assembly instructions.

|   |  |   |
|---|--|---|
|  <b>KTR KTR-Group</b> | <b>ROTEX®</b><br><b>Operating/Assembly instructions</b><br><b>Type A-H</b> | <b>KTR-N</b> 40226 EN<br><b>Sheet:</b> 6 of 19<br><b>Edition:</b> 4 |
|---|--|---|

## 2 Advice

### 2.5 Coupling selection



For a permanent and failure-free operation of the coupling it must be selected according to the selection instructions (according to DIN 740 part 2) for the particular application (see catalogue drive technology "ROTEX®").

If the operating conditions (performance, speed, modifications on engine and machine) change, the coupling selection must be reviewed.

Please make sure that the technical data regarding torque refer to the spider only. The transmittable torque of the shaft-hub-connection must be reviewed by the customer and is subject to his responsibility.

For drives subject to torsional vibrations (drives with cyclic stress due to torsional vibrations) it is necessary to perform a torsional vibration calculation to ensure a reliable selection. Typical drives subject to torsional vibrations are e. g. drives with diesel engines, piston pumps, piston compressors etc. If requested, KTR will perform the coupling selection and the torsional vibration calculation.



If the coupling is used in hazardous locations, the size must be selected such that there is a minimum safety of  $s = 2.0$  between the torque of the machine and the rated torque of the coupling or shaft-hub-connection.

### 2.6 Reference to EC Machinery Directive 2006/42/EC

The couplings supplied by KTR should be considered as components, not machines or partly completed machines according to EC Machinery Directive 2006/42/EC. Consequently KTR does not have to issue a declaration of incorporation. For details about safe assembly, start-up and safe operation please refer to the present operating/assembly instructions considering the warnings.

## 3 Storage, transport and packaging

### 3.1 Storage

The coupling hubs are supplied in preserved condition and can be stored at a dry and roofed place for 6 - 9 months.

The features of the coupling spiders (elastomers) remain unchanged for up to 5 years with favourable storage conditions.



The storage rooms must not include any ozone-generating devices like e. g. fluorescent light sources, mercury-vapour lamps or electrical high-voltage appliances.

Humid storage rooms are not suitable.

Please make sure that condensation is not generated. The best relative air humidity is less than 65 %.

### 3.2 Transport and packaging



In order to avoid any injuries and any kind of damage please always make use of proper transport and lifting equipment.

The couplings are packed differently each depending on size, number and kind of transport. Unless otherwise contractually agreed, packaging will follow the in-house packaging specifications of KTR.

|   |                         |                                   |
|---|-------------------------|-----------------------------------|
| Please observe protection note ISO 16016. | Drawn: 2017-05-24 Pz/At | Replacing: KTR-N dated 2017-05-16 |
|   | Verified: 2017-05-30 Pz | Replaced by:                      |



**4 Assembly**

The coupling is generally supplied in individual parts. Before assembly the coupling has to be inspected for completeness.

**4.1 Components of the coupling**

**Components of ROTEX®, type A-H, size 19 - 90**

| Component | Quantity        | Description  |
|-----------|-----------------|--|
| 1         | 2               | H clamping hub                                       |
| 2         | 1               | Spider   |
| 3         | 2 <sup>1)</sup> | Cap screws<br>DIN EN ISO 4762                        |
| 4         | 2 <sup>1)</sup> | Half-length taper<br>grooved pins<br>DIN EN ISO 8745 |

1) each clamping hub

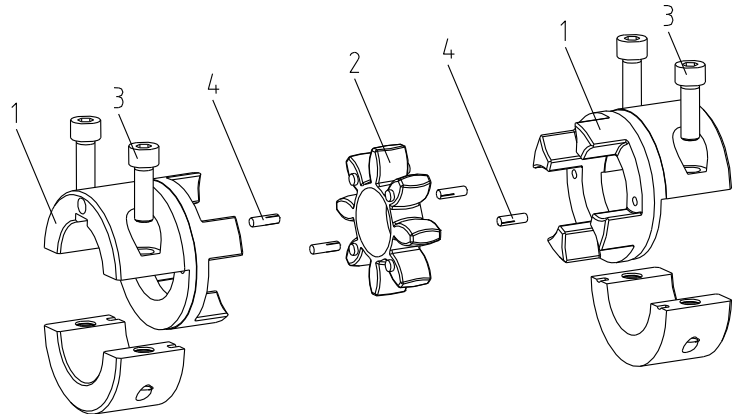

Illustration 3: ROTEX®, type A-H, size 19 - 90

**Components of ROTEX®, type A-H, size 100 - 125**

| Component | Quantity        | Description  |
|-----------|-----------------|--|
| 1         | 2               | H clamping hub                                       |
| 2         | 1               | Spider   |
| 3         | 4 <sup>1)</sup> | Cap screws<br>DIN EN ISO 4762                        |
| 4         | 2 <sup>1)</sup> | Half-length taper<br>grooved pins<br>DIN EN ISO 8745 |

1) each clamping hub

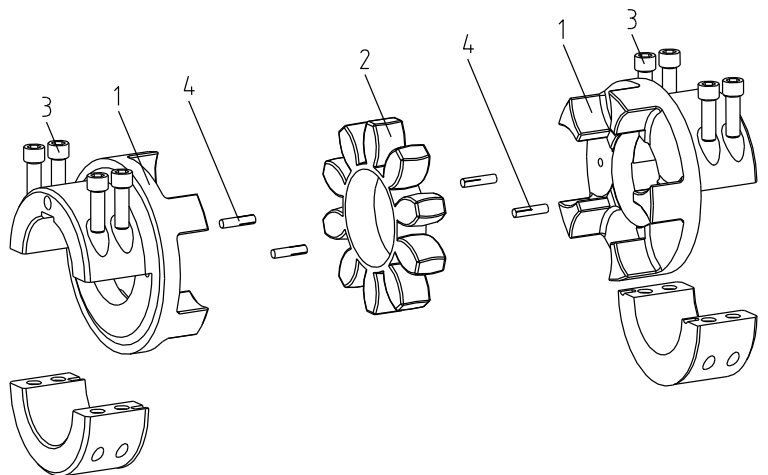

Illustration 4: ROTEX®, type A-H, size 100 - 125



Hubs without feather keyway may be used in category **3 only**.







|   |                         |                                   |
|---|-------------------------|-----------------------------------|
| Please observe protection note ISO 16016. | Drawn: 2017-05-24 Pz/At | Replacing: KTR-N dated 2017-05-16 |
|   | Verified: 2017-05-30 Pz | Replaced by:                      |



## 4 Assembly

### 4.1 Components of the coupling

#### Features of standard spiders

| Spider hardness<br>(Shore) | 92 Shore A  |   | 95/98 Shore A   |  | 64 Shore D  |   |
|----------------------------|---|---|---|--|---|---|
|                            | T-PUR®<br>(orange)  | PUR<br>(yellow)   | T-PUR®<br>(purple)  | PUR<br>(red)   | T-PUR®<br>(light green)   | PUR<br>(natural white <sup>1)</sup> )   |
| Marking<br>(colour)        |  |  |  |  |  |  |

1) Natural white with green marking of teeth

### 4.2 Advice for finish bore



The maximum permissible bore diameters  $d$  (see table 1 and 2 in chapter 1 - technical data) must not be exceeded. If these figures are disregarded, the coupling may tear. Rotating particles may cause danger to life.

- Hub bores machined by the customer have to observe concentricity or axial runout, respectively (see illustration 5).
- Please make absolutely sure to observe the figures for  $\varnothing d_{max}$ .
- Carefully align the hubs when the finish bores are drilled.

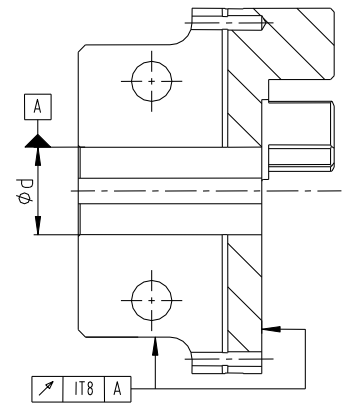

Illustration 5: Concentricity and axial runout



The customer bears the sole responsibility for all machining processes performed subsequently on unbored or pilot bored as well as finish machined coupling components and spare parts. KTR does not assume any warranty claims resulting from insufficient remachining.



KTR supplies unbored or pilot bored coupling components and spare parts only upon explicit request of the customer. These parts are additionally labelled with the symbol .



**4 Assembly****4.3 Assembly of the hubs**

We recommend to inspect bores, shaft, keyway and feather key for dimensional accuracy before assembly.



Please pay attention to the ignition risk in potentially explosive atmospheres!



With the assembly please make sure that the distance dimension E (see table 1 and 2) is observed to allow for axial clearance of the spider when in operation. Disregarding this advice may cause damage to the coupling.

- Remove the shells from the hub body.
- Fit the hub body along with the spider.
- Mount the fitted unit along with the shells and the clamping screws onto the shaft ends of the driving and driven machine.
- Hand-tighten the clamping screws so that the hubs and shells fit closely to the shaft.
- Shift the hubs in axial direction until the distance dimension E is achieved.
- Secure the hubs by tightening the clamping screws reciprocally. Tighten the screws by means of a suitable torque key to the tightening torques  $T_A$  specified in table 1 and 2.



If the shaft diameters with inserted feather key are smaller than dimension  $d_H$  (see table 1 and 2) of the spider, one or two shaft ends may protude into the spider.



If used in hazardous locations all screw connections must be secured against working loose additionally, e. g. conglutinating with Loctite (average strength).



Hubs without feather keyway may be used in category 3 only.

**4.4 Displacements - alignment of the couplings**

The displacement figures specified in tables 3 and 4 provide for sufficient safety to compensate for external influences like, for example, thermal expansion or foundation settling.



In order to ensure a long service life of the coupling and avoid danger with the use in potentially explosive atmospheres, the shaft ends must be accurately aligned. Please absolutely observe the displacement figures specified (see tables 3 and 4). If the figures are exceeded, the coupling will be damaged.



The more accurate the alignment of the coupling, the longer is its service life. If used in hazardous areas for the explosion group IIC (marking II 2GD c IIC T X), only half of the displacement figures (see tables 3 and 4) are permissible.

**Please note:**

- The displacement figures specified in tables 3 and 4 are maximum figures which must not arise in parallel. If radial and angular displacements arise at the same time, the permissible displacement values may only be used proportionally (see illustration 7).
- Please inspect with a dial gauge, ruler or feeler whether the permissible displacement figures of tables 3 and 4 can be observed.

**4 Assembly**

**4.4 Displacements - alignment of the couplings**

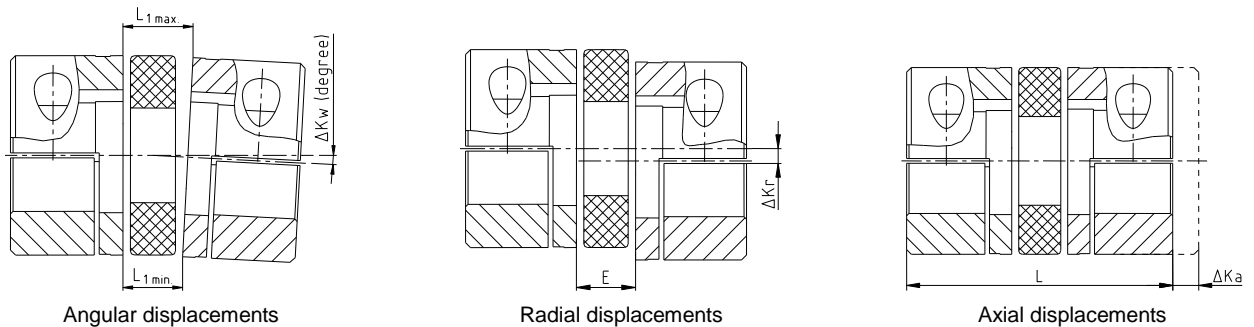

$$\Delta K_w = L_{1max.} - L_{1min.} \text{ [mm]}$$

Illustration 6: Displacements

$$L_{max} = L + \Delta K_a \text{ [mm]}$$

Examples of the displacement combinations specified in illustration 7:

Example 1:  
 $\Delta K_r = 30 \%$   
 $\Delta K_w = 70 \%$

Example 2:  
 $\Delta K_r = 60 \%$   
 $\Delta K_w = 40 \%$

Illustration 7:  
 Combinations of displacement

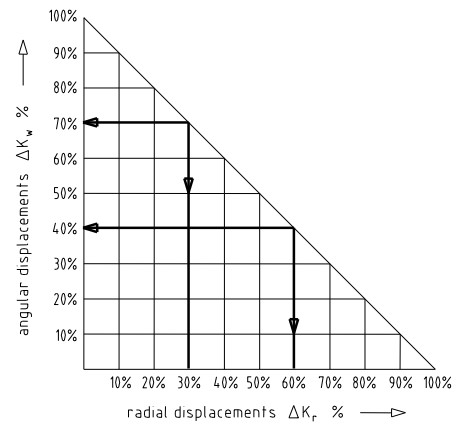

$$\Delta K_{total} = \Delta K_r + \Delta K_w \leq 100 \%$$

**Table 3: Displacement figures for 92 and 95/98 Shore A**

| Size   | 19       | 24   | 28   | 38   | 42   | 48   | 55   | 65   | 75   | 90   | 100  | 110  | 125  |
|--|----------|------|------|------|------|------|------|------|------|------|------|------|------|
| Max. axial displacement $\Delta K_a$ [mm]  | -0.5     | -0.5 | -0.7 | -0.7 | -1.0 | -1.0 | -1.0 | -1.0 | -1.5 | -1.5 | -1.5 | -2.0 | -2.0 |
|  | +1.2     | +1.4 | +1.5 | +1.8 | +2.0 | +2.1 | +2.2 | +2.6 | +3.0 | +3.4 | +3.8 | +4.2 | +4.6 |
| Max. radial displacement $\Delta K_r$ [mm] with  | 1500 rpm | 0.20 | 0.22 | 0.25 | 0.28 | 0.32 | 0.36 | 0.38 | 0.42 | 0.48 | 0.50 | 0.52 | 0.60 |
|  | 3000 rpm | 0.13 | 0.15 | 0.17 | 0.19 | 0.21 | 0.25 | 0.26 | 0.28 | 0.32 | 0.34 | 0.36 | -    |
| $\Delta K_w$ [degree]<br>max. angular displacement<br>with n=1500 rpm<br>$\Delta K_w$ [mm] | 1.2      | 0.9  | 0.9  | 1.0  | 1.0  | 1.1  | 1.1  | 1.2  | 1.2  | 1.2  | 1.2  | 1.3  | 1.3  |
|  | 0.82     | 0.85 | 1.05 | 1.35 | 1.70 | 2.00 | 2.30 | 2.70 | 3.30 | 4.30 | 4.80 | 5.60 | 6.50 |
| $\Delta K_w$ [degree]<br>max. angular displacement<br>with n=3000 rpm<br>$\Delta K_w$ [mm] | 1.1      | 0.8  | 0.8  | 0.9  | 0.9  | 1.0  | 1.0  | 1.1  | 1.1  | 1.1  | 1.1  | 1.2  | -    |
|  | 0.70     | 0.75 | 0.85 | 1.10 | 1.40 | 1.60 | 2.00 | 2.30 | 2.90 | 3.80 | 4.20 | 5.00 | -    |

**Table 4: Displacement figures for 64 Shore D**

| Size   | 19       | 24   | 28   | 38   | 42   | 48   | 55   | 65   | 75   | 90   | 100  | 110  | 125  |
|--|----------|------|------|------|------|------|------|------|------|------|------|------|------|
| Max. axial displacement $\Delta K_a$ [mm]  | -0.5     | -0.5 | -0.7 | -0.7 | -1.0 | -1.0 | -1.0 | -1.0 | -1.5 | -1.5 | -1.5 | -2.0 | -2.0 |
|  | +1.2     | +1.4 | +1.5 | +1.8 | +2.0 | +2.1 | +2.2 | +2.6 | +3.0 | +3.4 | +3.8 | +4.2 | +4.6 |
| Max. radial displacement $\Delta K_r$ [mm] with  | 1500 rpm | 0.13 | 0.15 | 0.18 | 0.21 | 0.23 | 0.25 | 0.27 | 0.30 | 0.34 | 0.36 | 0.37 | 0.43 |
|  | 3000 rpm | 0.09 | 0.10 | 0.13 | 0.15 | 0.16 | 0.18 | 0.19 | 0.21 | 0.24 | 0.25 | 0.26 | -    |
| $\Delta K_w$ [degree]<br>max. angular displacement<br>with n=1500 rpm<br>$\Delta K_w$ [mm] | 1.1      | 0.8  | 0.8  | 0.9  | 0.9  | 1.0  | 1.0  | 1.1  | 1.1  | 1.1  | 1.1  | 1.2  | 1.2  |
|  | 0.77     | 0.77 | 0.90 | 1.25 | 1.40 | 1.80 | 2.00 | 2.50 | 3.00 | 3.80 | 4.30 | 5.30 | 6.00 |
| $\Delta K_w$ [degree]<br>max. angular displacement<br>with n=3000 rpm<br>$\Delta K_w$ [mm] | 1.0      | 0.7  | 0.7  | 0.8  | 0.8  | 0.9  | 0.9  | 1.0  | 1.0  | 1.0  | 1.0  | 1.1  | -    |
|  | 0.70     | 0.67 | 0.80 | 1.00 | 1.30 | 1.60 | 1.80 | 2.20 | 2.70 | 3.50 | 4.00 | 4.90 | -    |

|   |  |   |
|---|--|---|
|  <b>KTR KTR-Group</b> | <b>ROTEX®</b><br><b>Operating/Assembly instructions</b><br><b>Type A-H</b> | KTR-N 40226 EN<br>Sheet: 11 of 19<br>Edition: 4 |
|   |  |   |
|   |  |   |

## 5 Start-up

Before start-up of the coupling, please inspect the tightening of the setscrews in the hubs, the alignment and the distance dimension E and adjust, if necessary, and also inspect all screw connections for the tightening torques specified, dependent on the type of coupling.



**If used in potentially explosive atmospheres the setscrews to fasten the hubs as well as all screw connections must be secured against working loose additionally, e. g. conglutinating with Loctite (average strength).**

Finally the coupling protection against accidental contact must be fitted. It is required in accordance with DIN EN ISO 12100 (Safety of Machinery) and the directive 2014/14/EU and must protect against

- access with the little finger
- falling down of solid foreign objects.

The cover may provide for openings intended for necessary heat dissipation. These openings have to comply with DIN EN ISO 13857.

The cover must be electrically conductive and included in the equipotential bonding. Bellhousings (magnesium share below 7.5 %) made of aluminium and damping rings (NBR) can be used as connecting element between pump and electric motor. The cover may only be taken off with standstill of the unit.



**If the couplings are used in locations subject to dust explosion and in mining the user must make sure that there is no accumulation of dust in a dangerous volume between the cover and the coupling. The coupling must not operate in an accumulation of dust.**

**For covers with unlocked openings on the top face no light metals must be used if the couplings are used as equipment of equipment group II (*if possible, from stainless steel*). If the couplings are used in mining (equipment group I M2), the cover must not be made of light metal. In addition, it must be resistant to higher mechanical loads than if it is used as equipment of equipment group II.**

During operation of the coupling, please pay attention to

- different operating noise
- vibrations occurring.



**If you note any irregularities with the coupling during operation, the drive unit must be switched off immediately. The cause of the breakdown must be specified by means of the table „Breakdowns“ and, if possible, be eliminated according to the proposals. The potential breakdowns mentioned can be hints only. To find out the cause all operating factors and machine components must be considered.**

### Coating of coupling:



**If coated (priming, paintings, etc.) couplings are used in potentially explosive atmospheres, the requirements on conductivity and coating thickness must be considered. In case of paintings up to 200 µm electrostatic load does not have to be expected. Multiple coatings exceeding 200 µm are prohibited for explosion group IIC.**

|   |                         |                                   |
|---|-------------------------|-----------------------------------|
| Please observe protection note ISO 16016. | Drawn: 2017-05-24 Pz/At | Replacing: KTR-N dated 2017-05-16 |
|   | Verified: 2017-05-30 Pz | Replaced by:                      |

## 6 Breakdowns, causes and elimination

The below-mentioned failures can lead to a use of the **ROTEX®** coupling other than intended. In addition to the specifications given in these operating and assembly instructions please make sure to avoid such failures. The errors listed can only be clues to search for the failures. When searching for the failure the adjacent components must generally be considered.



**If used other than intended the coupling can become a source of ignition.  
EU directive 2014/34/EU requires special care by the manufacturer and the user.**

General failures with use other than intended:

- Important data for the coupling selection were not forwarded.
- The calculation of the shaft-hub-connection was not considered.
- Coupling components with damage occurred during transport are assembled.
- If the heated hubs are assembled, the permissible temperature is exceeded.
- The fit of the components to be assembled is not coordinated with one another.
- Tightening torques have been fallen below/exceeded.
- Components are mixed up by mistake/assembled incorrectly.
- A wrong or no spider is inserted in the coupling.
- No original **KTR** components (purchased parts) are used.
- Old/already worn out spiders or spiders stored for too long are used.
- : The coupling used/the coupling protection used is not suitable for the operation in hazardous locations and does not correspond to EU directive 2014/34/EU, respectively.
- Maintenance intervals are not observed.

| Breakdowns  | Causes  | Hazard notes for potentially explosive atmospheres                         | Elimination   |
|---|---|--|---|
| Different operating noise and/or vibrations occurring | Misalignment  | Increased temperature on the spider surface; ignition risk by hot surfaces | 1) Set the unit out of operation<br>2) Eliminate the reason for the misalignment (e. g. loose foundation bolts, breaking of the engine mount, heat expansion of unit components, modification of the installation dimension E of the coupling)<br>3) For inspection of wear see item inspection |
|   | Wear of spider, short-term torque transmission due to metal contact | Ignition risk due to sparking  | 1) Set the unit out of operation<br>2) Disassemble the coupling and remove remainders of the spider<br>3) Inspect coupling components and replace coupling components that are damaged<br>4) Insert spider, assemble coupling components<br>5) Inspect alignment, adjust if necessary           |
|   | Screws for axial fastening of hubs working loose                    | Ignition risk due to hot surfaces and sparking                             | 1) Set the unit out of operation<br>2) Inspect alignment of coupling<br>3) Tighten the screws to fasten the hubs and secure against working loose<br>4) For inspection of wear see item inspection  |
| Breaking of cams                                      | Wear of spider, torque transmission due to metal contact            | Ignition risk due to sparking  | 1) Set the unit out of operation<br>2) Replace complete coupling<br>3) Inspect alignment  |
|   | Breaking of the cams due to high impact energy/overload             |  | 1) Set the unit out of operation<br>2) Replace complete coupling<br>3) Inspect alignment<br>4) Find out the reason for overload   |



## 6 Breakdowns, causes and elimination

| Breakdowns  | Causes  | Hazard notes for potentially explosive atmospheres                         | Elimination  |
|---|---|--|--|
| Breaking of cams  | Operating parameters do not meet with the performance of the coupling   | Ignition risk due to sparking  | <ol style="list-style-type: none"> <li>1) Set the unit out of operation</li> <li>2) Review the operating parameters and select a bigger coupling (consider mounting space)</li> <li>3) Assemble new coupling size</li> <li>4) Inspect alignment</li> </ol>   |
|   | Operating error of the unit   |  | <ol style="list-style-type: none"> <li>1) Set the unit out of operation</li> <li>2) Replace complete coupling</li> <li>3) Inspect alignment</li> <li>4) Instruct and train the service staff</li> </ol>  |
| Early wear of spider  | Misalignment  | Increased temperature on the spider surface; ignition risk by hot surfaces | <ol style="list-style-type: none"> <li>1) Set the unit out of operation</li> <li>2) Eliminate the reason for the misalignment (e. g. loose foundation bolts, breaking of the engine mount, heat expansion of unit components, modification of the installation dimension E of the coupling)</li> <li>3) For inspection of wear see item inspection</li> </ol>  |
|   | e. g. contact with aggressive liquids/oils, ozone influence, too high/low ambient temperatures etc. causing physical modification of the spider | Ignition risk due to sparking with metallic contact of the cams            | <ol style="list-style-type: none"> <li>1) Set the unit out of operation</li> <li>2) Disassemble the coupling and remove remainders of the spider</li> <li>3) Inspect coupling components and replace coupling components that are damaged</li> <li>4) Insert spider, assemble coupling components</li> <li>5) Inspect alignment, adjust if necessary</li> <li>6) Make sure that further physical modifications of the spider are excluded</li> </ol>                                   |
|   | Ambient/contact temperatures which are too high for the spider, max. permissible e. g. with T-PUR®<br>T4 = - 50 °C/<br>+ 120 °C                 |  | <ol style="list-style-type: none"> <li>1) Set the unit out of operation</li> <li>2) Disassemble the coupling and remove remainders of the spider</li> <li>3) Inspect coupling components and replace coupling components that are damaged</li> <li>4) Insert spider, assemble coupling components</li> <li>5) Inspect alignment, adjust if necessary</li> <li>6) Inspect and adjust ambient/contact temperature (possibly corrective by using different spider materials)</li> </ol>   |
| Early wear of spider (liquefaction of material inside the spider cam) | Vibrations of drive   |  | <ol style="list-style-type: none"> <li>1) Set the unit out of operation</li> <li>2) Disassemble the coupling and remove remainders of the spider</li> <li>3) Inspect coupling components and replace coupling components that are damaged</li> <li>4) Insert spider, assemble coupling components</li> <li>5) Inspect alignment, adjust if necessary</li> <li>6) Find out the reason for the vibrations (possibly corrective by spider with lower or higher Shore hardness)</li> </ol> |



**If you operate with a worn spider (see item 10.3) and with subsequent contact of metal parts a proper operation meeting the explosion protection requirements and acc. to directive 2014/34/EU is not ensured.**

|   |  |   |
|---|--|---|
|  <b>KTR KTR-Group</b> | <b>ROTEX®</b><br><b>Operating/Assembly instructions</b><br><b>Type A-H</b> | KTR-N 40226 EN<br>Sheet: 14 of 19<br>Edition: 4 |
|---|--|---|

## 7 Disposal

In respect of environmental protection we would ask you to dispose of the packaging or products on termination of their service life in accordance with the legal regulations and standards that apply, respectively.

- **Metal**  
Any metal components have to be cleaned and disposed of by scrap metal.
- **Nylon materials**  
Nylon materials have to be collected and disposed of by a waste disposal company.

## 8 Maintenance and service

**ROTEX®** is a low-maintenance coupling. We recommend to perform a visual inspection on the coupling **at least once a year**. Please pay special attention to the condition of the coupling spiders.

- Since the flexible machine bearings of the driving and driven side settle during the course of load, please inspect the alignment of the coupling and re-align the coupling, if necessary.
- The coupling components have to be inspected for damages.
- The screw connections have to be inspected visually.



**Having started up the coupling the tightening torques of the screws have to be inspected during the usual inspection intervals.**



**With the use in potentially explosive atmospheres please observe chapter 10.2 Inspection intervals for couplings in  potentially explosive atmospheres.**

## 9 Spares inventory, customer service addresses

A basic requirement to ensure the readiness for use of the coupling is a stock of the most important spare parts on site.

Contact addresses of the KTR partners for spare parts and orders can be obtained from the KTR homepage at [www.ktr.com](http://www.ktr.com).



**KTR does not assume any liability or warranty for the use of spare parts and accessories which are not provided by KTR and for the damages which may incur as a result.**

|   |                         |                                   |
|---|-------------------------|-----------------------------------|
| Please observe protection note ISO 16016. | Drawn: 2017-05-24 Pz/At | Replacing: KTR-N dated 2017-05-16 |
|   | Verified: 2017-05-30 Pz | Replaced by:                      |

## 10 Enclosure A

Advice and instructions regarding the use in  hazardous locations

| Type | Hub design         | Sizes    | Material |
|------|--------------------|----------|----------|
| A-H  | 7.5, 7.6, 7.8, 7.9 | 19 - 125 | Steel    |



Hubs, clamping hubs or similar types without feather keyways may be used in category 3 only.

If the coupling is used in hazardous locations, the size must be selected such that there is a minimum safety of  $s = 2.0$  between the torque of the machine and the rated torque of the coupling or shaft-hub-connection.

### 10.1 Intended use in potentially explosive atmospheres

#### Conditions of operation in potentially explosive atmospheres

ROTEX® couplings are suitable for the use according to EU directive 2014/34/EU.

#### 1. Industry (with the exception of mining)

- Equipment group II of category 2 and 3 (*coupling is not approved for equipment group 1*)
- Media class G (*gases, fogs, steams*), zone 1 and 2 (*coupling is not approved for zone 0*)
- Media class D (*dusts*), zone 21 and 22 (*coupling is not approved for zone 20*)
- Explosion group IIC (*explosion class IIA and IIB are included in IIC*)

#### Temperature class:

| T-PUR®            |  |                          | PUR               |  |                          |
|-------------------|--|--------------------------|-------------------|--|--------------------------|
| Temperature class | Ambient or operating temperature $T_a$ | Max. surface temperature | Temperature class | Ambient or operating temperature $T_a$ | Max. surface temperature |
| T3, T2, T1        | - 50 °C to + 120 °C <sup>1)</sup>      | + 140 °C <sup>2)</sup>   | T4, T3, T2, T1    | - 30 °C to + 90 °C <sup>1)</sup>       | + 110 °C <sup>2)</sup>   |
| T4                | - 50 °C to + 115 °C                    | + 135 °C                 | T5                | - 30 °C to + 80 °C                     | + 100 °C                 |
| T5                | - 50 °C to + 80 °C                     | + 100 °C                 | T6                | - 30 °C to + 65 °C                     | + 85 °C                  |
| T6                | - 50 °C to + 65 °C                     | + 85 °C                  |                   |  |                          |

#### Explanation:

The maximum surface temperatures each result from the maximum permissible ambient or operating temperature  $T_a$  plus the maximum temperature increase  $\Delta T$  of 20 K which has to be taken into account.

- 1) The ambient or operating temperature  $T_a$  is limited to + 90 °C (valid for T-PUR® only: + 120 °C) due to the permissible permanent operating temperature of the elastomers used.
- 2) The maximum surface temperature of + 110 °C (valid for T-PUR® only: + 140 °C) applies for the use in locations which are potentially subject to dust explosion, too.

#### 2. Mining

Equipment group I of category M2 (coupling is not approved for equipment group M1).

Permissible ambient temperature - 30 °C to + 90 °C (valid for T-PUR® only: - 50 °C to + 120 °C).



**10 Enclosure A**

Advice and instructions regarding the use in  hazardous locations

**10.2 Inspection intervals for couplings in  potentially explosive atmospheres**

| Explosion group            | Inspection intervals   |
|----------------------------|--|
| 3G<br>3D                   | For couplings which are classified in category 3G or 3D the operating and assembly instructions that are usual for standard operation apply. During the standard operation which has to be subject to the ignition risk analysis the couplings are free from any ignition source. Merely the temperature increase produced by self-heating and depending on the coupling type has to be considered: for ROTEX®: $\Delta T = 20 \text{ K}$  |
| II 2GD c IIB<br>T4, T5, T6 | An inspection of the torsional backlash and a visual inspection of the flexible spider must be performed after 3,000 operating hours for the first time, at the latest after 6 months after start-up of the coupling.<br>If you note insignificant or no wear on the spider upon this initial inspection, further inspections can each be performed after 6,000 operating hours or at the latest after 18 months, provided that the operating parameters remain the same.<br>If you note significant wear during the initial inspection so that it would be recommendable to replace the spider, please find out the cause according to the table „Breakdowns“, if possible.<br>The maintenance intervals must be adapted to the modified operating parameters without fail. |
| II 2GD c IIC<br>T4, T5, T6 | An inspection of the torsional backlash and a visual inspection of the flexible spider must be performed after 2,000 operating hours for the first time, at the latest after 3 months after start-up of the coupling.<br>If you note insignificant or no wear on the spider upon this initial inspection, further inspections can each be performed after 4,000 operating hours or at the latest after 12 months, provided that the operating parameters remain the same.<br>If you note significant wear during the initial inspection so that it would be recommendable to replace the spider, please find out the cause according to the table „Breakdowns“, if possible.<br>The maintenance intervals must be adapted to the modified operating parameters without fail. |

 **Hubs, clamping hubs or similar types without feather keyways may be used in category 3 only.**

**ROTEX® coupling**

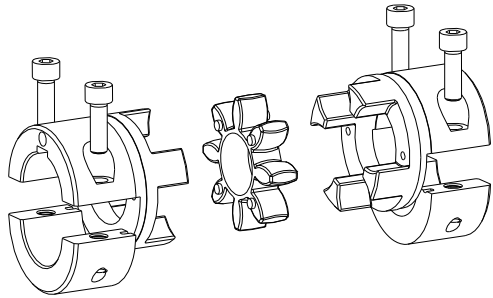

Illustration 8: ROTEX®, type A-H

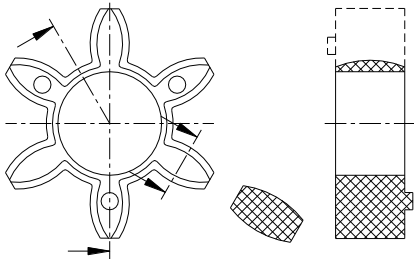

Illustration 9: ROTEX® spider

Here the backlash between the cams of the coupling and the flexible spider must be inspected by means of a feeler gauge.  
When reaching the wear limit **maximum friction**, the spider must be replaced immediately, irrespective of the inspection intervals.

|   |                         |                                   |
|---|-------------------------|-----------------------------------|
| Please observe protection note ISO 16016. | Drawn: 2017-05-24 Pz/At | Replacing: KTR-N dated 2017-05-16 |
|   | Verified: 2017-05-30 Pz | Replaced by:                      |





10 Enclosure A

Advice and instructions regarding the use in  hazardous locations

10.3 Standard values of wear

In case of a backlash > X mm, the flexible spider must be replaced.

Reaching the limits for replacing depends on the operating conditions and the existing operating parameters.



In order to ensure a long service life of the coupling and avoid danger with the use in potentially explosive atmospheres, the shaft ends must be accurately aligned. Please absolutely observe the displacement figures specified (see tables 3 and 4). If the figures are exceeded, the coupling will be damaged.

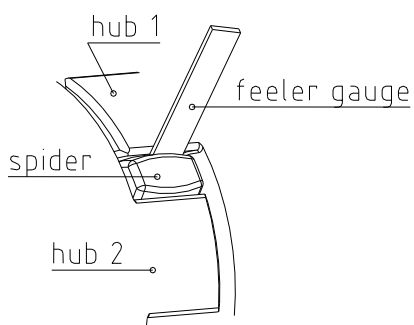

Illustration 10: Inspection of the limit of wear

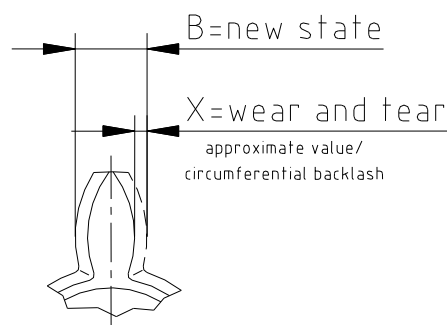

Illustration 11: Wear of spider

Table 5:

| Size | Limits of wear (friction) |  | Size | Limits of wear (friction) |  |
|------|---------------------------|--|------|---------------------------|--|
|      | $X_{max.}$ [mm]           |  |      | $X_{max.}$ [mm]           |  |
| 19   | 3                         |  | 65   | 5                         |  |
| 24   | 3                         |  | 75   | 6                         |  |
| 28   | 3                         |  | 90   | 8                         |  |
| 38   | 3                         |  | 100  | 9                         |  |
| 42   | 4                         |  | 110  | 9                         |  |
| 48   | 4                         |  | 125  | 10                        |  |
| 55   | 5                         |  |      |                           |  |

10.4 Permissible coupling materials in  potentially explosive atmospheres

In the explosion groups **IIA**, **IIB** and **IIC** the following materials may be combined:

- EN-GJL-250 (GG 25)
- EN-GJS-400-15 (GGG 40)
- Steel
- Stainless steel

Semifinished products made of aluminium with a magnesium share of up to 7.5% and a yield point of  $R_{p0.2} \geq 250 \text{ N/mm}^2$  are permitted for the use in hazardous locations.

**Aluminium diecast** is generally excluded for potentially explosive atmospheres.

|   |           |                  |              |                        |
|---|-----------|------------------|--------------|------------------------|
| Please observe protection note ISO 16016. | Drawn:    | 2017-05-24 Pz/At | Replacing:   | KTR-N dated 2017-05-16 |
|   | Verified: | 2017-05-30 Pz    | Replaced by: |                        |



10 Enclosure A

Advice and instructions regarding the use in  hazardous locations

10.5  marking of coupling for potentially explosive atmospheres

Couplings for the use in potentially explosive atmospheres are marked on at least one component completely and on the remaining components by an  label on the outside diameter of the hub or on the front side each for the operating conditions permitted. The flexible spider is excluded.

Short labelling:  
(standard)



II 2GD c IIC T X/I M2 c X

Complete labelling:  
(valid for T-PUR® only)





II 2G c IIC T6, T5, T4 resp. T3 - 50 °C ≤ T<sub>a</sub> ≤ + 65 °C, + 80 °C,  
+ 115 °C resp. + 120 °C  
II 2D c T 140 °C/I M2 c - 50 °C ≤ T<sub>a</sub> ≤ + 120 °C

Complete labelling:  
(valid for PUR only)



II 2G c IIC T6, T5 resp. T4 - 30 °C ≤ T<sub>a</sub> ≤ + 65 °C, + 80 °C resp.  
+ 90 °C  
II 2D c T 110 °C/I M2 c - 30 °C ≤ T<sub>a</sub> ≤ + 90 °C

The labelling with explosion group IIC includes the explosion groups IIA and IIB.

If the symbol  was stamped in addition to , the coupling component was supplied unbored or pilot bored by KTR.



10 Enclosure A

Advice and instructions regarding the use in  hazardous locations

10.6 EU Certificate of conformity

## EU Certificate of conformity

corresponding to EU directive 2014/34/EU dated 26 February 2014  
and to the legal regulations

The manufacturer - KTR Systems GmbH, D-48432 Rheine - states that the

### flexible ROTEX® couplings

in an explosion-proof design described in these operating/assembly instructions are devices corresponding to article 2, 1. of directive 2014/34/EU and comply with the general safety and health requirements according to enclosure II of directive 2014/34/EU.

The coupling described in here complies with the specifications of the following standards/guidelines:

- DIN EN 1127-1
- DIN EN 1127-2
- DIN EN 13463-1
- DIN EN 13463-5
- CLC/TR 50404

The ROTEX® is in accordance with the specifications of the directive 2014/34/EU. One or several standards specified in the corresponding type examination certificate IBExU13ATEXB016 X were in part replaced by updated versions.

KTR Systems GmbH being the manufacturer confirms that the product mentioned above is in accordance with the specifications of the new directives, too.

According to article 13 (1) b) ii) of directive 2014/34/EU the technical documentation is deposited with the institution:

IBExU  
Institut für Sicherheitstechnik GmbH  
Fuchsmühlenweg 7

09599 Freiberg

Rheine,  
Place

2017-05-16  
Date

i. V.  
Reinhard Wibbeling  
Engineering/R&D

i. V.  
Michael Brüning  
Product Manager