

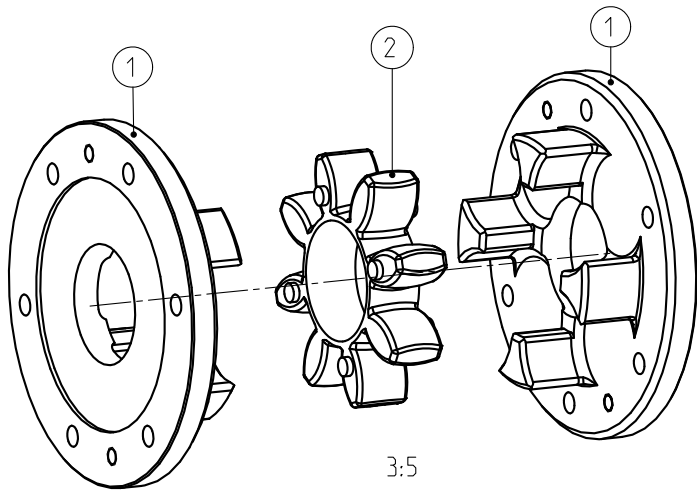

Drehmoment / Torque  
 Zahnkranz / spider 92 Sh A T-PUR  
 (Zahnkranz / spider 92 Sh A)  
 $T_{KN} = 190 \text{ Nm}$   
 $T_{Kmax} = 380 \text{ Nm}$

Massenträgheitsmoment / Mass moment of inertia

$J_{ges.} = 0.0025855584 \text{ kgm}^2$



Oberflächengüte nach DIN ISO 1302 Reihe 2 Surface quality acc. to DIN ISO 1302 line 2		Schutzvermerk ISO 16016 beachten Note protection mark acc. to ISO 16016			
Allgemeintoleranzen nach DIN ISO 2768 - mH General tolerances acc. to DIN ISO 2768 - mH		Masstab Scale	9:10	Format DIN Size	A3
<b>ROTEX 38</b> DF			 KTR-Kupplungstechnik GmbH D-48407 Rheine		
gezeichnet drawn	Werkstoff Material	Teilnummer Part number	Kz	Lfd.-Nr. Current number	Index Change
Datum 20.01.12	DIN		M	422896	1
Name SCHP	Gewicht Weight	1.507			